

COUNCIL AGENDA STATEMENT



Meeting Date: January 13, 2026
From: Carlos A. Solis, P.E. Dir of Public Works & Eng.
To: Honorable Mayor and City Councilmembers
Through: George Garrett, City Manager

Agenda Item: **Resolution 2026-06**, Authorizing A “Piggyback” Purchase Utilizing The Sourcewell Master Agreement #041525 Pursuant To The City’s Purchasing Policies And Procedures And Approving The Purchase Of Eight Freestanding Solar Light Poles And Fixtures For The New Pickleball Courts At Oceanfront Park From Fonroche Lighting America In An Amount Not To Exceed \$41,226.00; Authorizing The City Manager To Enter Into Agreements In Connection Therewith, And Expending Budgeted Funds; And Providing For An Effective Date:

BACKGROUND & JUSTIFICATION:

The City has recently approved the development of new Pickleball Courts to be constructed at Oceanfront Park, to include lighting for the project. The City has decided to pursue solar lights for this project in lieu of hard-wired system. The proposed system will operate in a similar fashion to the hard-wired system, activated at sunset and operated by motion sensors so that the lights remain off when the courts are not in use. The initial cost of lighting for the project as received in the bids for the court project was \$193,420, which included extending a new service to the court area, controllers, and new panels. After further research, we have determined that the proposed solar lights provide the same lighting for the project at a substantial initial installation savings along with the savings of power usage going forward. The net savings to the City is \$152,194 plus the monthly savings of electric cost. Proposed installation is 100% warranted for eight years should any component of the system fails. After eight years the battery component would likely need replacement and can easily be replaced at a cost of approximately \$600 per light, which would easily be covered by the power savings over the eight years.

CONSISTENCY CHECKLIST:

	Yes	No
1. Comprehensive Plan	_____	_____
2. Other _____	<u> X </u>	_____

FISCAL NOTE:

The FY26 Adopted Capital Infrastructure Fund budget includes appropriations of \$660,000 for the new pickleball courts project at Ocean Front Park.

RECOMMENDATION: Approve Resolution

**CITY OF MARATHON, FLORIDA
RESOLUTION 2026-06**

A RESOLUTION OF THE CITY COUNCIL OF THE CITY OF MARATHON, FLORIDA AUTHORIZING A “PIGGYBACK” PURCHASE UTILIZING THE SOURCEWELL MASTER AGREEMENT #041525 PURSUANT TO THE CITY’S PURCHASING POLICIES AND PROCEDURES AND APPROVING THE PURCHASE OF EIGHT FREESTANDING SOLAR LIGHT POLES AND FIXTURES FOR THE NEW PICKLEBALL COURTS AT OCEANFRONT PARK FROM FONROCHE LIGHTING AMERICA IN AN AMOUNT NOT TO EXCEED \$41,226.00; AUTHORIZING THE CITY MANAGER TO EXECUTE THE AGREEMENT, APPROPRIATE FUNDS/EXPEND BUDGETED FUNDS AND PROVIDING FOR AN EFFECTIVE DATE

WHEREAS, pursuant to Ordinance 2024-13, the City adopted purchasing policies and procedures (the “Purchasing Policies and Procedures”) after determining that it was fiscally prudent and in the City’s best interest to adopt policies and procedures for City employees and officials regarding the acquisition and purchase of contractual services, equipment, goods, and other similar types of services; and

WHEREAS, the Purchasing Policies and Procedures allow the City Council to enter into contracts for materials, supplies, equipment, public improvements or services without competitive bidding by utilizing existing contract terms and prices entered into by other local, state or federal governmental authorities that followed a competitive bidding procedure leading to the award of the contract in question; and

WHEREAS, the City desires to take advantage of the Sourcewell master agreement #041525, the purchase of eight freestanding solar light poles and fixtures for the new pickleball courts at oceanfront park from Fonroche lighting America in an amount not to exceed \$41,226.00.

NOW, THEREFORE, BE IT RESOLVED BY THE CITY COUNCIL OF THE CITY OF MARATHON, FLORIDA, THAT:

Section 1. The above recitals are true and correct and incorporated herein.

Section 2. The City Council hereby authorizes the City Manager to enter into an agreement and expend budgeted funds on behalf of the City for the purchase of eight freestanding solar light poles and fixtures for the new pickleball courts at oceanfront park from Fonroche lighting America in an amount not to exceed \$41,226.00.

Section 3. This resolution shall take effect immediately upon its adoption.

**PASSED AND APPROVED BY THE CITY COUNCIL OF THE CITY OF
MARATHON, FLORIDA, THIS __ DAY OF _____ 2026.**

THE CITY OF MARATHON, FLORIDA

Lynny Del Gaizo, Mayor

AYES:
NOES:
ABSENT:
ABSTAIN:

ATTEST:

Diane Clavier, City Clerk

(City Seal)

**APPROVED AS TO FORM AND LEGALITY FOR THE USE
AND RELIANCE OF THE CITY OF MARATHON, FLORIDA ONLY:**

Steve Williams, City Attorney

Lighting Design

11/19/2025

City of marathon FL- Pickleball courts

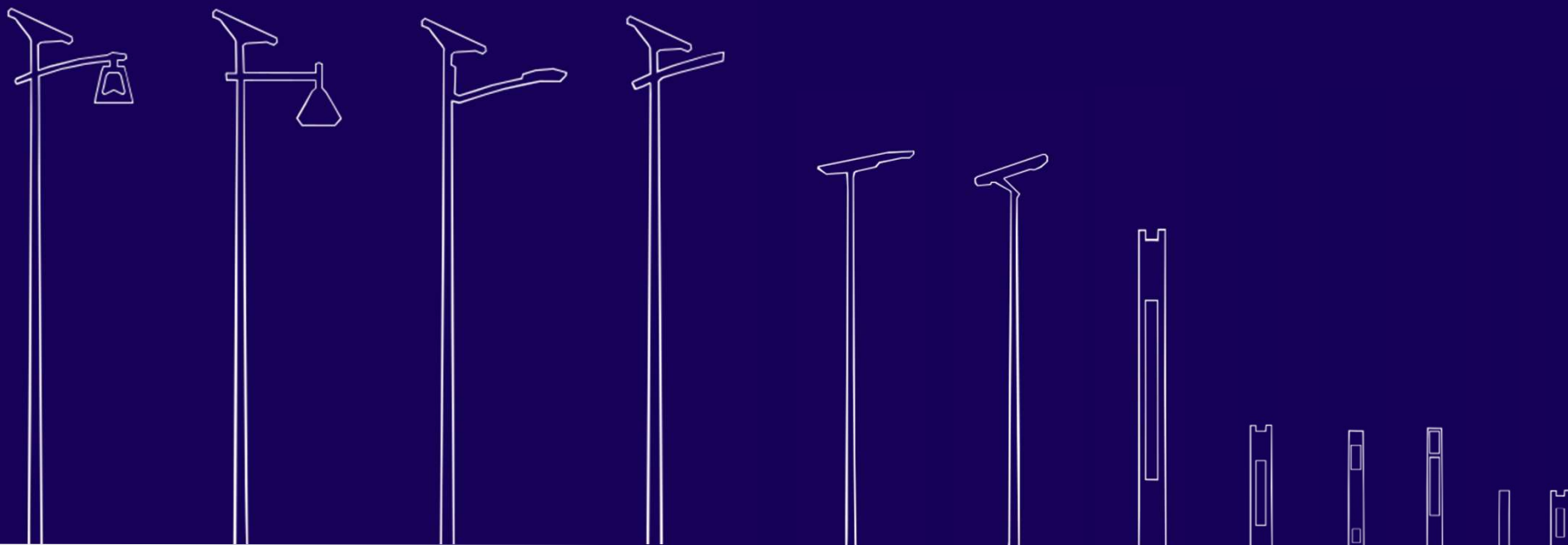

SOLAR
IS THE NEW
STANDARD

Lighting Your Project	3-9
Visual Integration	10-11
Technical Specification	12-21
Appendices	22

Lighting Your Project

01

HELIA

Light Set Free – Skylight Collection



HELIA luminaires will be installed to enhance your space with light. True concentrations of technology, they deliver a unique and fully customizable lighting signature. Their refined design allows them to blend harmoniously into the landscape, both day and night.

HELIA lifts constraints and invites you to gaze at the sky.



Layout Plan



HELIA - Up

Photometric Study

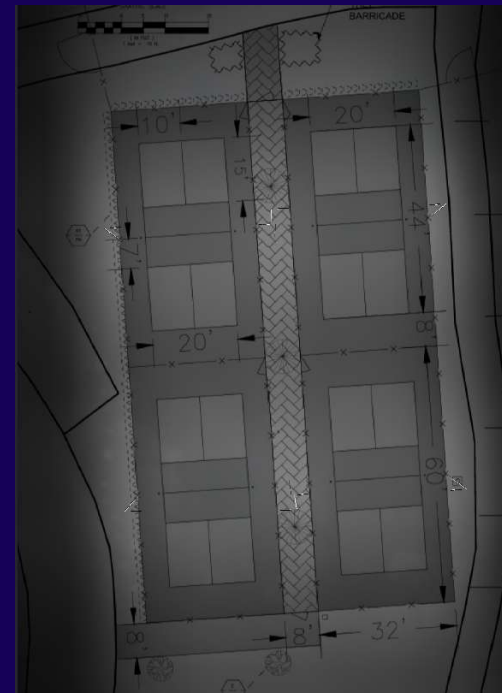
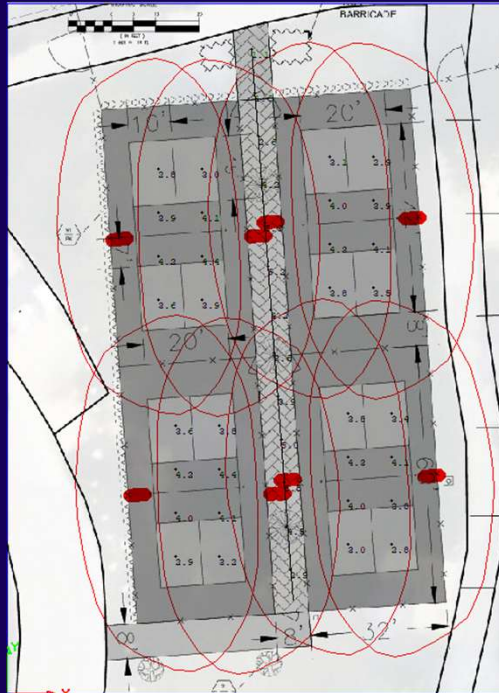

Zone	Results		Quantity
	Average Illuminance (fc)	Uniformity (Avg/Min)	
Pickleball Courts	{3.65 – 3.78}	{1.34 – 1.28}	8
Walk Path	3.82	3.47	
TOTAL			8

Technical Specifications

02

Study Process -

For Lighting 365 Nights Per Year

[1] Site Meteorological Data ANALYSIS

For your lighting project we have taken into account:
The conditions of use (orientation, panel tilt)
External parameters (shading, temperature, solar calendar)

[2] SIMULATION of products over a typical year

Our solar sizing software has made it possible to validate the lighting equipment for your needs.
The operation is simulated over a typical year, average of the last 10 years.

[3] SIZING to create a tailor-made project

- The key criteria to optimize your project:
- Average state of charge of the battery in the year
 - Minimum state of charge
 - Comparison of energy created / energy consumed
 - Worst case scenario (longest night; lowest solar radiation)

[4] RESULTS

The solution we offer is the most optimized to fully fulfill lighting needs.

GPA Coordinates : 24.722903, -81.04995

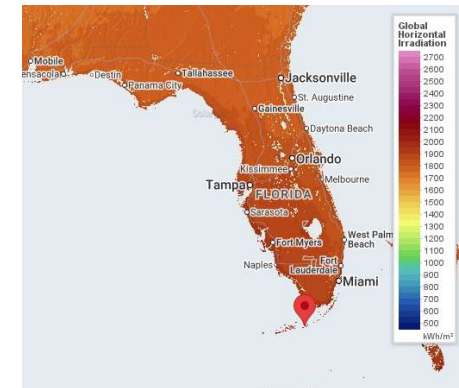

Helia Up – Product sheet

QUANTITY : 8

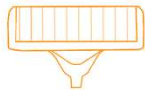

PHOTOVOLTAIC MODULE

Power	150 Wc
Tilt	10°





BATTERY STORAGE

Battery	936 Wh
---------	--------

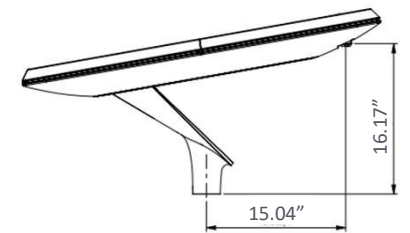

LED LUMINAIRE

Efficacy	200 lm/W
Color Temperature	3000 K
Tilt	0°

STRUCTURE

Height	20'
Color	Black Shadow
Treatments	-

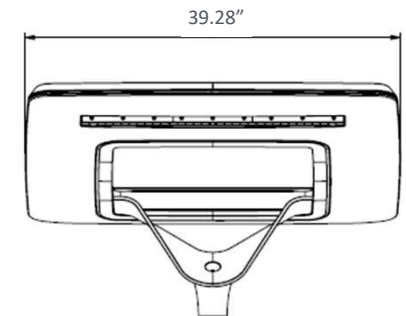
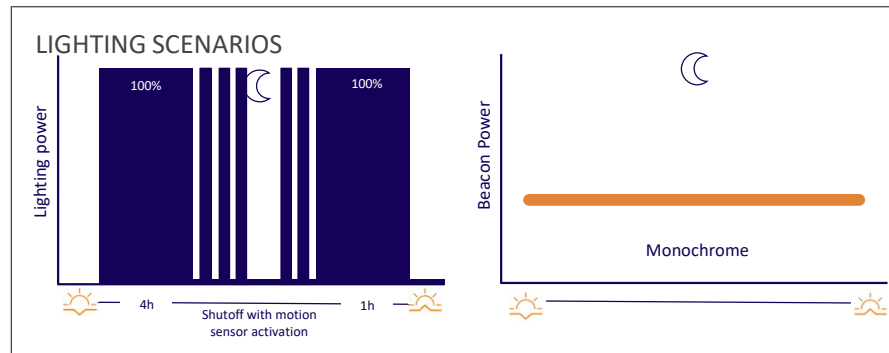

Appendices

03

Pickleball Courts



8840 Cypress Waters Blvd
Coppell, TX 75019
Phone Number: (339) 225 4530
www.fonrochesolarlighting.com

Lighting Plan Rev B
Project Number: G10502

By: Mateo Chevalier
m.chevalier@fonroche-lighting.com
Date: 12/1/2025

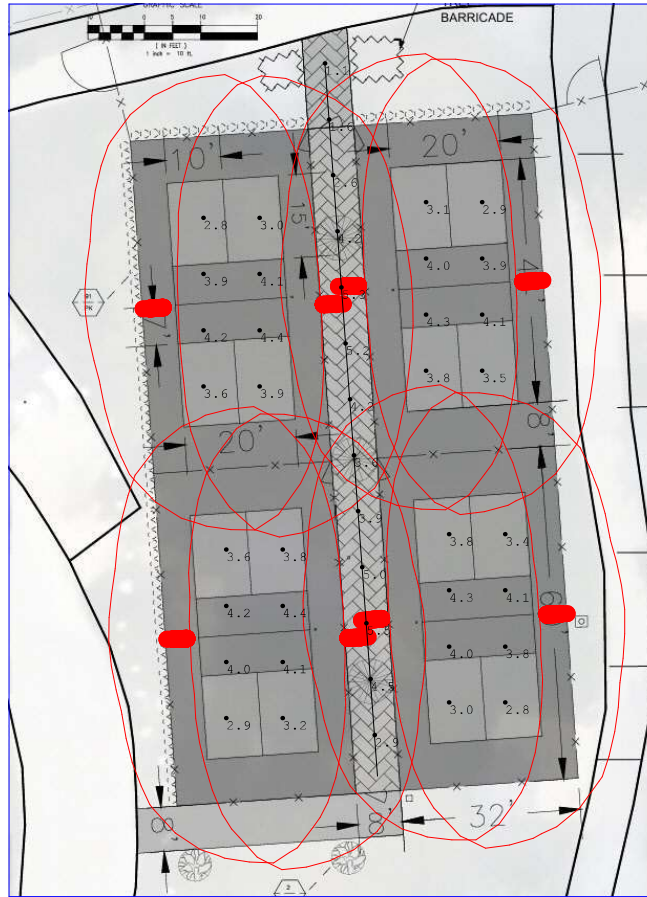

Luminaire Schedule								
Symbol	Qty	Label	Arrangement	LLF	Luminaire Lumens	Luminaire Watts	Mounting Height	Arm
	8	HELIA UP-3K-27W	Single	0.900	5474	27	21.5	1.25

Calculation Summary							
Label	CalcType	Units	Avg	Max	Min	Avg/Min	Max/Min
Pickleball Court	Illuminance	Fc	3.74	4.4	2.8	1.34	1.57
Pickleball Court_1	Illuminance	Fc	3.78	4.4	2.9	1.30	1.52
Pickleball Court_2	Illuminance	Fc	3.70	4.3	2.9	1.28	1.48
Pickleball Court_3	Illuminance	Fc	3.65	4.3	2.8	1.30	1.54
Walk Path	Illuminance	Fc	3.82	5.5	1.1	3.47	5.00

Pickleball Courts



Lighting Plan Rev B
Project Number: G10502

By: Mateo Chevalier
m.chevalier@fonroche-lighting.com
Date: 12/1/2025

8840 Cypress Waters Blvd
Coppell, TX 75019
Phone Number: (339) 225 4530
www.fonrochesolarlighting.com



Pickleball Courts



Lighting Plan Rev B
Project Number: G10502

By: Mateo Chevalier
m.chevalier@fonroche-lighting.com
Date: 12/1/2025

8840 Cypress Waters Blvd
Coppell, TX 75019
Phone Number: (339) 225 4530
www.fonrochesolarlighting.com

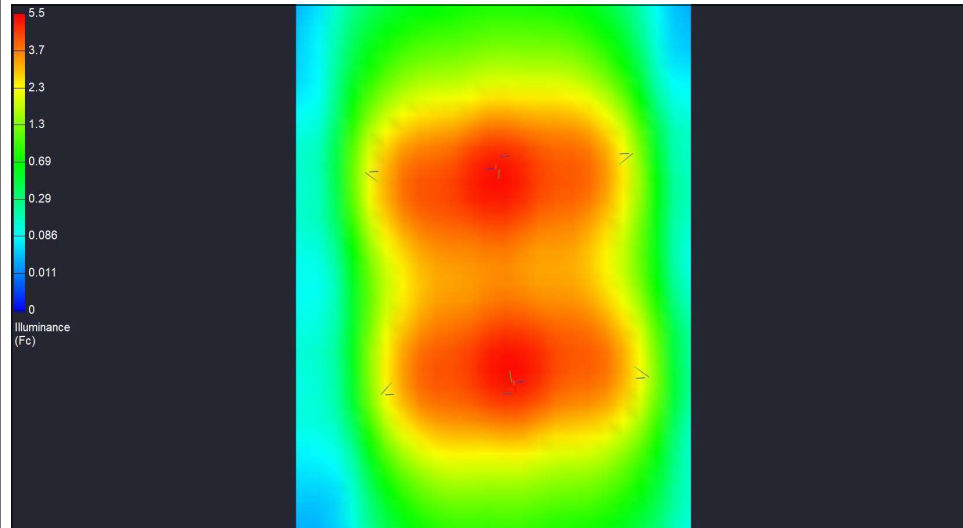



SOLAR
IS THE NEW
STANDARD

Prepared By: Mateo CHEVALIER

Sales Contact: Eleazar Acosta – eleazar.acosta@fonroche.us

Phone. : 339-225-4530

Sales@Fonroche.US

FONROCHE LIGHTING | 2224 SE Loop 820 Building C, Fort Worth, TX 76140

www.FonrocheSolarLighting.com

Opportunity Owner	Eleazar Acosta	Quote Number	00087388
Payment Terms	50% deposit, 50% Net 30 from Ship Date-contingent on credit approval	Quote Name	G10502-City of marathon FL- Pickleball courts-RevB
Shipping Terms	Prices are FOB Origin	Quote Date	12/1/2025
		Quote Expiration Date	3/1/2026
		Est. Lead Time	Within 6 Weeks
		Ship To Name	City of Marathon
		Ship To	United States

Shipping estimated; final cost determined on day of shipping and added to invoice.

Shipping fees do not include offloading at the delivery site. It is the customer's responsibility to arrange for any necessary equipment or personnel to unload the shipment upon arrival.

Fonroche is not in charge of or responsible for utility lines. Fonroche positions its lights on each layout to provide the proper photometric results. It is solely the responsibility of the customer to do their own due diligence in cooperation with the local utility to determine easement/spacing requirements from the utility lines, as well as any other requirements of the local utility.

Beware of Fraud: Any advance payment request will only be made on the basis of a proforma invoice sent by Fonroche Lighting America.

Fonroche Model Number	Fonroche Product Description	Price System	Quantity	Amount
[Helia-3K-T2] [150-3P] Fixture Color: BK POLE: 20Ft. Round Tapered Pole-Direct Burial-- No Arm-Pole Color:	Helia Solar Lighting Assembly with 936Wh-24V NiMH Battery , special extreme temperature (from -40F to +158F), 1 x 150W solar module with Top of Pole mount. Intelligent BMS, programmable control system, and integrated motion detector. Provisioned for Single Fixture configuration. Single Helia Fixture Color Temp 3K Dist. Type T2-Fixture Color: 20Ft. Round Tapered Pole-Direct Burial-- No Arm-Pole Color is 8 Year Warranty All Night Lighting 365 Days a Year - Full Battery Replacement Assumes No Shading Assumes little or no snow 10 Degrees Tilt 100% =27 Watts worst case conditions.T-PM: 4 hrs. @100% T-N (Balance of night) @0% T-AM: 1 hrs. @100%	USD 4,571.00	8.00	USD 36,568.00
Total Line Items				USD 36,568.00
Programming,Pkg, Ship & Handling Est.				USD 4,658.00
Quote Total				USD 41,226.00

This quotation is subject to the following terms and conditions

Seller's Terms and Conditions of Sale in effect on the date of this order shall apply to this quote and are hereby incorporated by reference. Seller's Terms and Conditions of Sale may be viewed at <https://www.fonrochesolarlighting.com/about-us/terms/>.

Pricing is based on Fonroche Lighting America's Standard Terms & Conditions and any additional terms stipulated herein. It is the Representative's responsibility to convey these terms to the customer. Without prior written approval from Fonroche Lighting America's Sales Director, any deviation from these terms may constitute a change in this pricing at the time of order.

